

Owner's Manual

TroposAir

Fresco

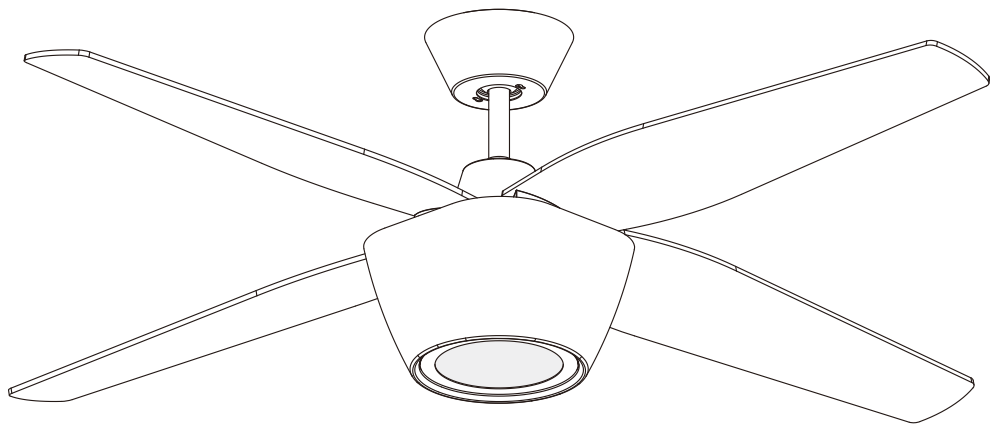

4BE52+LED

This instruction contains 6 pages:

Page 1: Foreword

Page 2: Unpack and inspect parts contained

Page 3: Notes before installation and Hanging system installation

Page 4: Wire connection

Page 5: Canopy installation / Blade installation

Page 6: Remote



Toll Free: 1-855-676-7247

WARNING : Read and follow these instructions carefully and be mindful of all warnings shown throughout.

Net weight

KGS.

LBS.

READ AND SAVE THESE INSTRUCTIONS

WARNING : TO REDUCE THE RISK OF FIRE, ELECTRICAL SHOCK, OR INJURY TO PERSONS, PLEASE OBSERVE THE FOLLOWING :

- 1]. To ensure the success of the installation, be sure to read the instructions and review the diagrams thoroughly before beginning. Two people recommended for fan installation.
- 2]. To avoid possible electric shock, be sure electricity is turned off at the main power box before wiring. All electrical connections must be made in accordance with local codes, ordinances and/or the National Electric Code. If you are unfamiliar with the methods of installing electrical wiring and products, secure the services of a qualified and licensed electrician as well as someone who can check the strength of the supportive ceiling members and make the proper installations and connections.
- 3]. Make sure that your installation site will not allow rotating fan blades to come in contact with any object. Blades should be at least 7 feet from floor when fan is in operation.
- 4]. If possible, mount ceiling fan on a ceiling joist - the joist must be able to support the motion and weight of the moving fan. If the fan will be mounted on a ceiling outlet box, a 4" x 2-1/8" deep METAL octagon box is required ; one UL listed as " suitable for fan support ". The box and its supporting members must not be able to twist or work loose. **DO NOT USE PLASTIC BOXES.** Installation on a concrete ceiling should be performed by qualified personnel.
- 5]. Blades should be attached after motor housing is hung and in place. Fan motor housing should be kept in carton until ready to be installed to protect its finish. If you are installing more than one ceiling fan, make sure that you do not mix fan blade sets.
- 6]. After making electrical connections, spliced conductors should be turned upward and pushed carefully up into outlet box. The wires should be spread apart with the grounded conductor and the equipment - grounding conductor on one side of the outlet box and the " HOT " wires on the other side.
- 7]. Electrical diagrams are for reference only. Light kits that are not packed with the fan must be ETL listed and should be installed per the light kit's installation instructions.
- 8]. After fan is completely installed, check to make sure that all connections are secure to prevent fan from falling and/or causing damage or injury.
- 9]. The fan can be made to work immediately after installation. The bearings are adequately charged with grease so that, under normal conditions, further lubrication should not be necessary.
- 10]. The fan must be turned off and stopped before reversing fan direction.
- 11]. **LED light kit included.**
- 12]. **This fan is reversible.**
- 13]. **This fan is controlled by remote.**
- 14]. **This fan is suitable for indoor location use.**



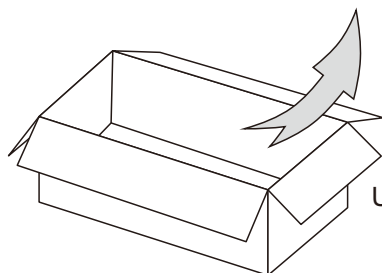
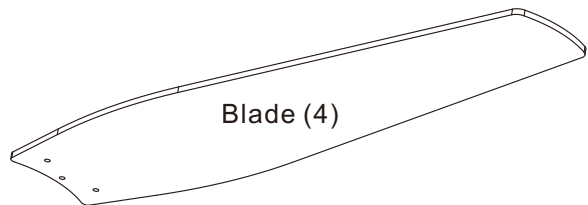
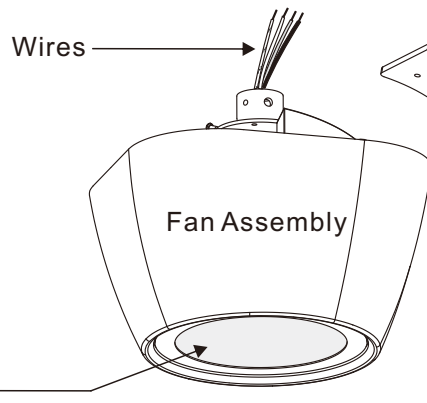
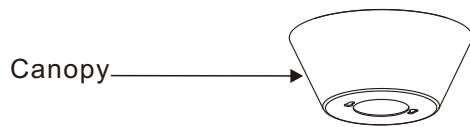
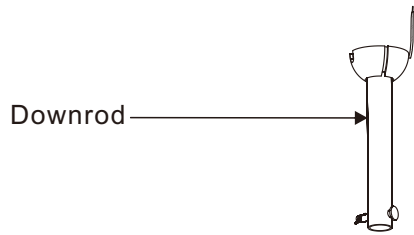
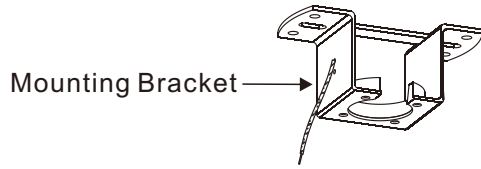





Unpack and inspect fan carefully to be certain all contents are included.



Unit pack / all in one box

Hardware Bag

For Mounting Plate:

- Flat Washer x2  
- Spring Washer x2  
- Machine Screw x2  
- Wood Screw x2  

For Blade Installation:

Paper Washer x10 (one spare washer included)



Blade Screw x 10 (one spare screw included)



For Blade Balance :

Balanced slice x 1

Weight block (3G x 3)



Remote

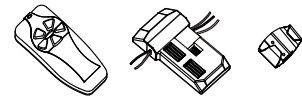

Hardware Bag

Wood Screw x 2

Wire Nut x 5



WARNING: blades should be at least 7 feet from floor

Note 1:

Turn off power at breaker box to avoid possible electrical shock.

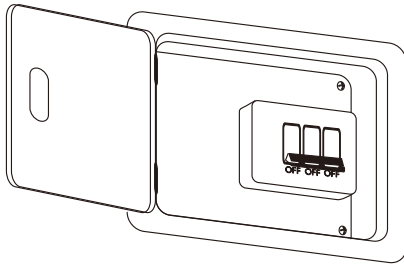

Note 2:

Use metal outlet box suitable for fan support. Outlet box must support 35 lbs min.

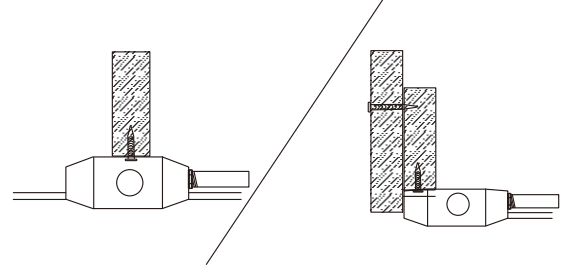

1. HANGING SYSTEM INSTALLATION

1A. Installing mounting bracket to ceiling outlet box

- 1 Install mounting bracket to outlet box in ceiling by using screws included with the outlet box and washers from the hardware bag.
- 2 Loosen the screws at Mounting Bracket.

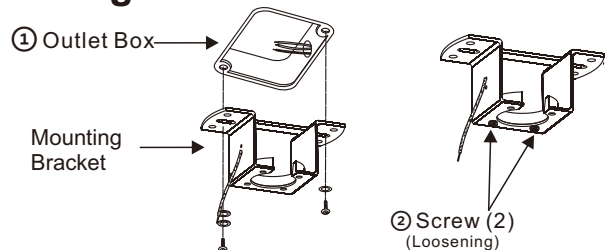

1B. Installing Downrod and Yoke

- 1 Remove cross pin and cotter pin from downrod.
- 2 Insert downrod through canopy and yoke cover assembly, and feed motor lead wires through downrod.
- 3 Loosen 2 downrod jam screws at yoke. Insert downrod assembly into yoke.
- 4 Insert the cross pin through yoke & downrod and secure with cotter pin.
- 5 Tighten both downrod jam screws to further secure downrod.
- 6 Attach wire connectors from yoke cover assembly and from fan together.

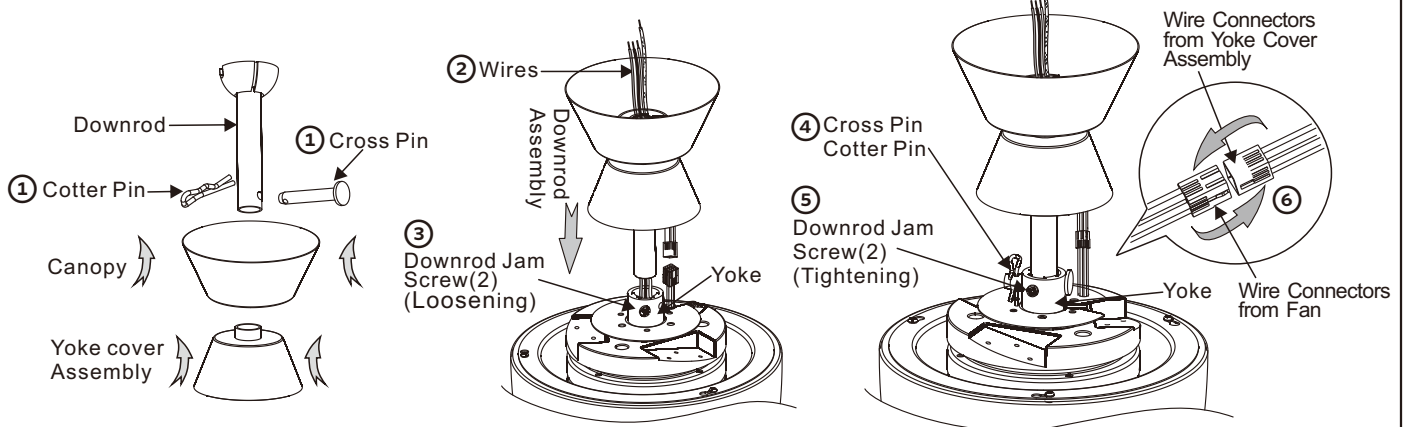

1C. Hanging the fan

Lift fan assembly onto mounting bracket.

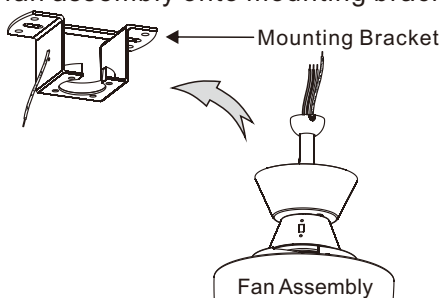

Rotate fan so that the groove on the ball engages the ridge in the mounting bracket.

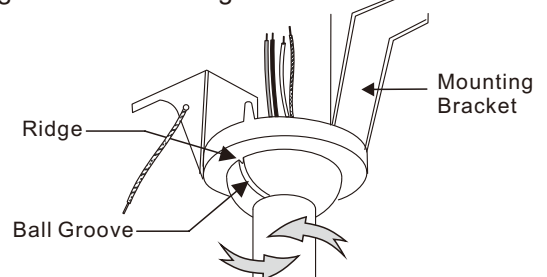

2. WIRE CONNECTION

2A. Making electrical wire connection.

Follow diagram below and make sure that all exposed wires are secured inside wire nuts.
Note: Wires from house may vary in color and may not include ground wire (green).
After wiring is completed, collect wires neatly inside hanging base.

- *White wire from house to white wire from receiver
- *Black wire from house to black wire from receiver
- *Blue wire from fan to blue wire from receiver.
- *White wire from fan to white wire from receiver
- *Black wire from fan to black wire from receiver
- *Secure with twist - lock wire nuts. (Included)
- *Ground wire from house to green wire from mounting bracket & downrod.

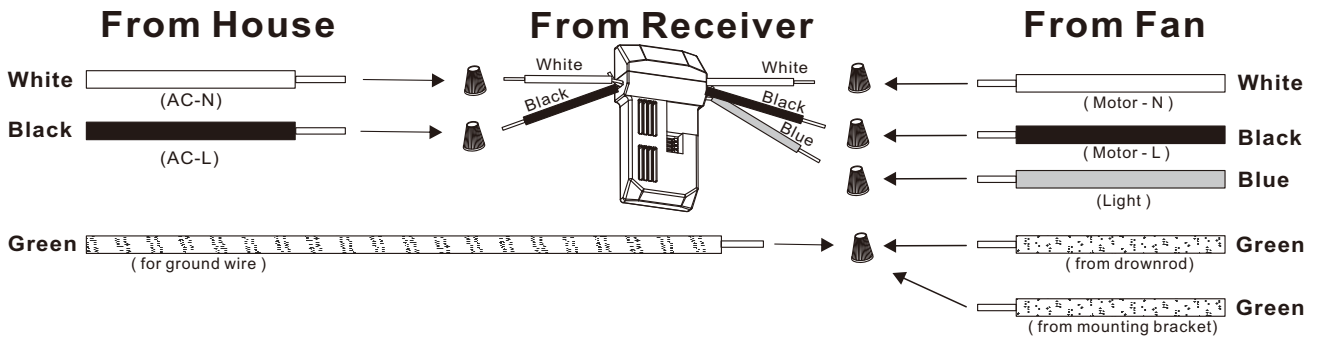

2B. Setting code switches for transmitter

Remote controls are tuned to operate together using 4 switches for 16 possible code combinations.

1. Setting the code on the TRANSMITTER

- ① Remove battery cover.
- ② Slide code switch randomly using a small screwdriver or ball point pen to slide each switch firmly up or down.
- ③ Install 9V DC battery. (Included)
- ④ Install battery cover on transmitter.

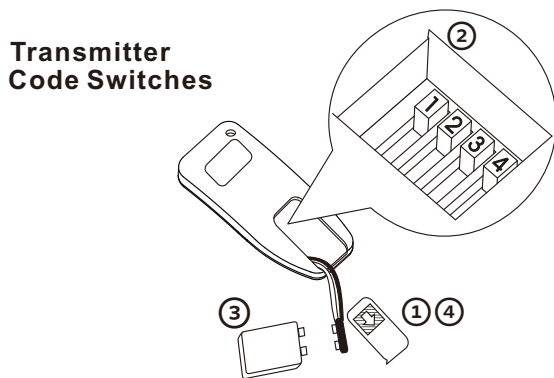

2. Setting the code on the RECEIVER

Slide code switches on the Receiver to be the SAME POSITIONS as set on your Transmitter.

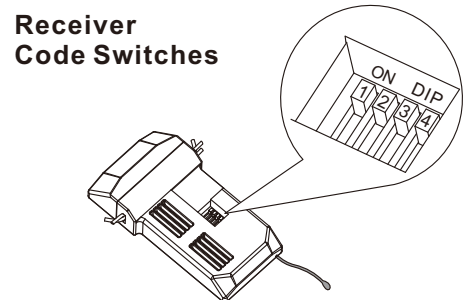

2C. Insert receiver into mounting bracket

NOTE: Do not squeeze all the wires while inserting the receiver into the mounting bracket.

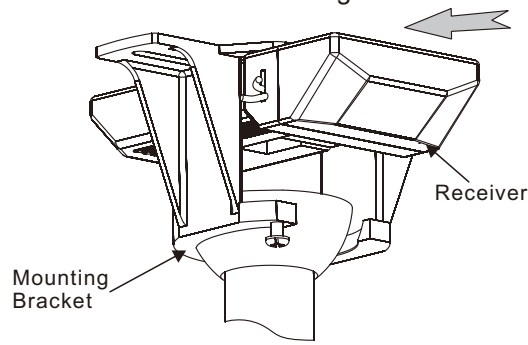

3. CANOPY INSTALLATION

Note: Two screws are pre-installed on mounting bracket for canopy installation.

- ① Push up canopy until two screws pre-screwed on mounting bracket are engaged with two key holes on canopy.
- ② Rotate canopy slightly until two pre-installed screw heads are engaged in the narrow end of key holes.
- ③ Tighten both screws.

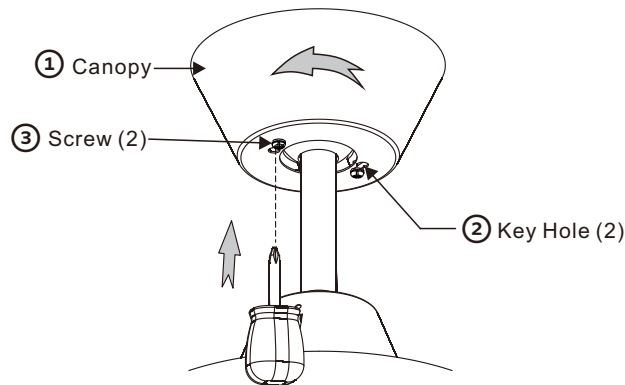

4. BLADES INSTALLATION

- ① Attach blade to blade holder with blade screws & paper washers provided in hardware bag. Make sure that all screws are firmly tightened.
- ② Pull down the yoke cover to cover yoke, and tighten the set screw on top of the yoke cover assembly.

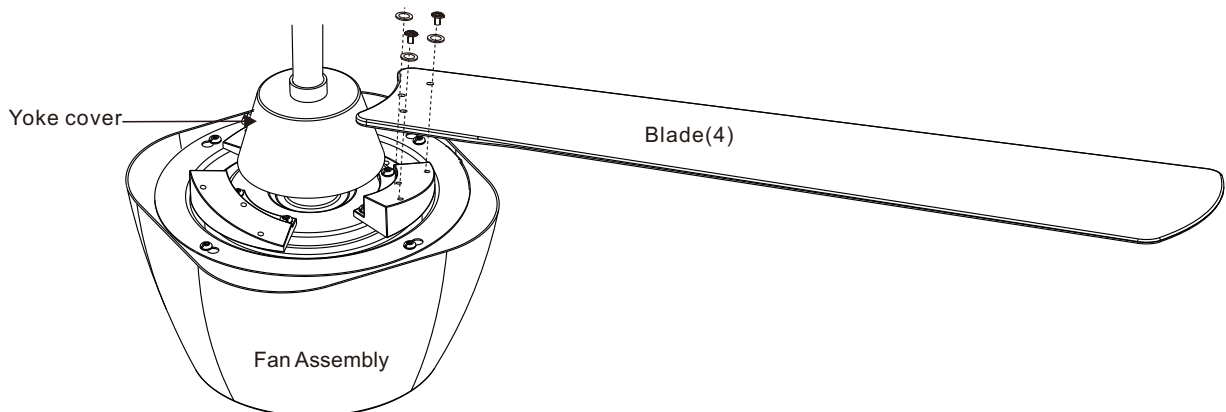

5. REMOTE

NOTE : Make sure transmitter and receiver have the same code for fan operation.

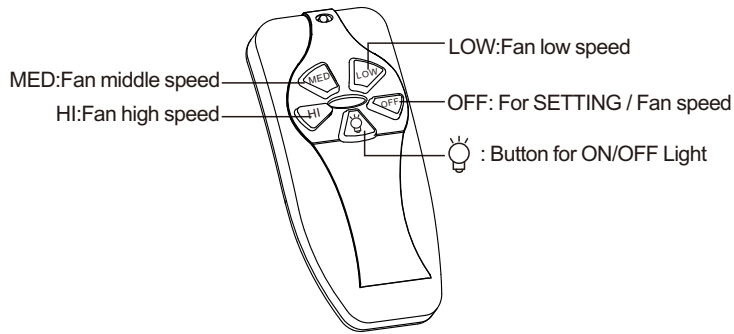

6. Turn on the power - your fan is ready for operation.

